

Growatt 2500MTL-S/3000MTL-S/3600MTL-S/
4200 MTL-S/5000MTL-S/5500MTL-S



Leading - edge Technology

- ▶ Double MPPT Tracker, MPPT tracking accuracy more than 99.5%
- ▶ Max. Efficiency 97.9%, European Efficiency 97.4%
- ▶ Integrated DC switch for added safety protection
- ▶ Transformerless design and high power density, offer lighter and more convenient installation
- ▶ 5 years standard warranty
- ▶ Power factor continuously adjustable
- ▶ Flexible communication connection, support RF, WiFi, Ethernet
- ▶ Comply with European, Asia-Pacific safety regulations

Growatt 2.5-5.5K MTL-S topology

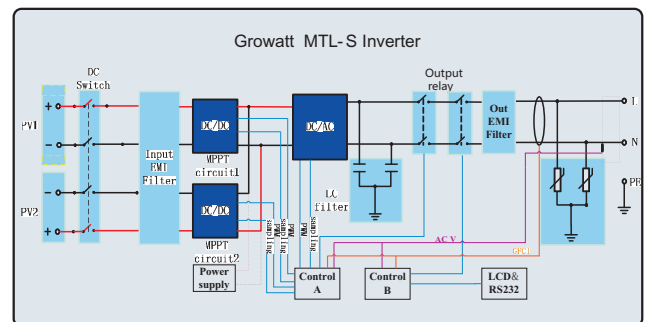

GROWATT NEW ENERGY TECHNOLOGY Co.,LTD

A: No.28 Guanghai Road, Longteng Community, Shiyan, Baoan District, Shenzhen, P.R.China.

T: + 86 755 2747 1900 F: + 86 755 2749 1460 E: info@ginverter.com

Datasheet	Growatt 2500MTL-S	Growatt 3000MTL-S	Growatt 3600MTL-S	Growatt 4200MTL-S	Growatt 5000MTL-S	Growatt 5500MTL-S
Input Data						
Max. recommended PV power (for module STC)	2900W	3500W	4100W	4800W	5300W	5750W
Max. DC voltage	500V	500V	550V	550V	550V	550V
Start voltage	100V	100V	100V	100V	100V	100V
PV voltage range	70V-500V	70V-500V	70V-550V	70V-550V	70V-550V	70V-550V
MPP work voltage range/nominal voltage	80V-500V /360V	80V-500V /360V	80V-550V /360V	80V-550V /360V	80V-550V /360V	80V-550V /360V
Full load dc voltage range	130V-450V	160V-450V	190V-500V	150V-500V	160V-500V	175V-500V
Max. input current of tracker A/tracker B	10A/10A	10A/10A	10A/10A	15A/15A	15A/15A	15A/15A
Max. input current per string of tracker A/tracker B	10A/10A	10A/10A	10A/10A	15A/15A	15A/15A	15A/15A
Number of independent MPP trackers / strings per MPP tracker	2/1	2/1	2/1	2/1	2/1	2/1
Output (AC)						
Rated AC output power	2500W	3000W	3600W	4200W	4600W	5000W
Max. AC apparent power	2500VA	3000VA	3600VA	4200VA	4600VA	5000VA
Max. output current	11.3A	13.6A	16.3A	19A	20.9A	22.7A
AC nominal voltage; range	220V/230V /240V; 180Vac-280Vac	220V/230V/240V; 180Vac - 280Vac	220V/230V/240V; 180Vac - 280Vac	220V,230V,240V; 180Vac - 280Vac	220V,230V,240V; 180Vac - 280Vac	220V,230V,240V; 180Vac - 280Vac
AC grid frequency; range	50Hz,60Hz / ± 5Hz	50Hz,60Hz / ± 5Hz	50Hz,60Hz / ± 5Hz	50Hz,60Hz / ± 5Hz	50Hz,60Hz / ± 5Hz	50Hz,60Hz / ± 5Hz
Phase factor at rated power	1	1	1	1	1	1
Displacement power factor, configurable	0.8leading... 0.95lagging	0.8leading... 0.95lagging	0.8leading... 0.95lagging	0.8leading... 0.95lagging	0.8leading... 0.95lagging	0.8leading... 0.95lagging
THDI	<3%	<3%	<3%	<3%	<3%	<3%
AC connection	Single phase	Single phase	Single phase	Single phase	Single phase	Single phase
Efficiency						
Max. efficiency	97.6%	97.6%	97.9%	97.9%	97.9%	97.9%
Euro weighted efficiency	97%	97%	97.4%	97.4%	97.4%	97.4%
MPPT efficiency	99.5%	99.5%	99.5%	99.5%	99.5%	99.5%
Protection Devices						
DC reverse polarity protection	yes	yes	yes	yes	yes	yes
DC switch rating for each MPPT	yes	yes	yes	yes	yes	yes
Output over current protection	yes	yes	yes	yes	yes	yes
Output over voltage protection-varistor	yes	yes	yes	yes	yes	yes
Ground fault monitoring	yes	yes	yes	yes	yes	yes
Grid monitoring	yes	yes	yes	yes	yes	yes
Integrated all - pole sensitive leakage current monitoring unit	yes	yes	yes	yes	yes	yes
General Data						
Dimensions (W / H / D) in mm	355*419*138	355*419*138	355*419*138	355*419*138	355*374*158	355*374*158
Weight	14KG	14KG	14KG	14KG	14.5KG	14.5KG
Operating temperature range	- 25°C ... +60°C	- 25°C ... +60°C	- 25°C ... +60°C	- 25°C ... +60°C	- 25°C ... +60°C	- 25°C ... +60°C
Noise emission (typical)	≤25 dB(A)	≤25 dB(A)	≤25 dB(A)	≤25 dB(A)	≤25 dB(A)	≤25 dB(A)
Altitude	2000m without derating	2000m without derating	2000m without derating	2000m without derating	2000m without derating	2000m without derating
Self-Consumption night	< 0.5 W	< 0.5 W	< 0.5 W	< 0.5 W	< 0.5 W	< 0.5 W
Topology	Transformerless	Transformerless	Transformerless	Transformerless	Transformerless	Transformerless
Cooling concept	Natural	Natural	Natural	Natural	Natural	Natural
Environmental Protection Rating	IP65	IP65	IP65	IP65	IP65	IP65
Relative humidity	100%	100%	100%	100%	100%	100%
Features						
DC connection	H4/MC4(opt)	H4/MC4(opt)	H4/MC4(opt)	H4/MC4(opt)	H4/MC4(opt)	H4/MC4(opt)
AC connection	Connector	Connector	Connector	Connector	Connector	Connector
Display	LCD	LCD	LCD	LCD	LCD	LCD
Interfaces: RS232 / RF / Wi-Fi / Ethernet	yes / opt / opt / opt	yes / opt / opt / opt	yes / opt / opt / opt	yes / opt / opt / opt	yes / opt / opt / opt	yes / opt / opt / opt
Warranty: 5 years / 10 years	yes / opt	yes / opt	yes / opt	yes / opt	yes / opt	yes / opt
Certificates and Approvals						
CE, IEC62109, G83, VDE0126-1-1, G59, AS4777, AS/NZS 3100, CEI0-21, VDE-AR-N4105, EN50438, CQC						